

zortrax

3D Printer User Guide

M300 Dual



Table of contents

Introduction	3
Intended Use of Zortrax Printers	3
General Safety Information	4
Warning and Safety Labels on Zortrax Devices	6
Learn More About the Zortrax M300 Dual	7
How does the Zortrax 3D printer work?	8
What's in the Box	9
Main Components	10
Zortrax 3D Printing Technology Glossary	12
First Use Preparation	18
Connecting the printer to a network	26
Firmware Update	30
Navigating through the Menu	31
Material Loading	33
Platform Calibration	35
Nozzle Alignment Calibration	37
Z-SUITE Installation	40
Starting and Removing a Print	40
Available Materials	45
Basic Maintenance and Service Work	45
Support and Troubleshooting	51
Specification	58
Recycling	61

Introduction

Read this User Guide carefully and thoroughly before operating Zortrax products for the first time. The User Guide contains basic information about the 3D printer, safety and protection guidelines as well as advice on preparing the machine for the first printing and basic maintenance work. Ignorance and non-compliance with these instructions may result in property damage, injuries, device failures, or lower quality of 3D prints. It is also necessary to ensure that every 3D printer user knows, fully understands, and follows the instructions provided in this User Guide.

The Manufacturer makes every effort to ensure that Zortrax products are safe in transportation, installation, usage, storage, and disposal. However, given the lack of direct and indirect control over the device and a number of other factors influencing the device, the Manufacturer is not responsible for damage, injuries, failures, and costs resulting from improper transportation, installation, usage, storage, and disposal.

Furthermore, the users should take into consideration the risk of possible damage of the device which may result from defects in material and workmanship.

Intended Use of Zortrax Printers

The Zortrax M300 Dual works in the Layer Plastic Deposition Plus (LPD Plus) technology, in which previously melted materials are deposited on a surface layer after layer in order to form a predesigned shape. The extruder is equipped with several heating points which allow the melted materials to exit the nozzles and be deposited onto the heated platform without causing blockages.

The users are responsible for qualifying and determining the intended use of 3D printed models. The Manufacturer takes no responsibility for any use of the printed objects, especially when those objects constitute a part of safety equipment or strictly regulated medical, military, or space science equipment.

Due to the size and specificity, Zortrax devices are not intended for use by children under the age of 14 and people with reduced manual, motor and psychomotor skills. The Manufacturer recommends providing assistance and guidance to people with disabilities and older adults who wish to operate the printers.

General Safety Information

This User Guide contains important safety directions that should be followed during installation and operation of the M300 Dual. It also mentions situations which require special attention and includes warnings against negligence and misuse that could cause damage or injuries.

Always read the safety data sheets available at: <https://zortrax.com/filaments/>. They are a source of basic information and safety procedures for the materials you use. It is essential to update the firmware to avoid any kind of failures. Visit <https://zortrax.com> regularly to learn about the latest news and updates.

The 3D printer operates at high temperatures and has easily accessible movable components, therefore, you must be particularly careful when handling or operating the device. It is extremely important to avoid situations that may lead to burns or interference in the device's proper functioning.

Do not leave the machine unattended during the print job - check it periodically for proper functioning in order to avoid potential accidents or breakdowns. Turn off the printer once the print job is finished. Monitor your device for wear and tear regularly. Contact our Support Center at: <https://support.zortrax.com/> for assistance while replacing worn or broken parts.

Keep the printer away from heat sources, fire, flammable materials, humidity as well as water and other liquids. Place the machine away from any equipment emitting radiation. To prevent any inadvertent use, keep the device out of reach of children and animals. It is forbidden to shake or drop the printer as it may cause breakdowns. The equipment is not intended for use in a potentially explosive environment.

Health and Safety at Work

All service and maintenance activities as well as device operation require wearing safety gloves included in the Starter Kit. Wearing safety gloves is also advised while removing finished prints from the platform.

The Manufacturer strongly recommends setting up a special room dedicated only to 3D printing. The room should be properly ventilated. At the same time, the Manufacturer does not recommend staying in a room where devices have been 3D printing for a long time. The vapors released during the printing process do not pose a direct hazard, but they can have negative effects when combined with accumulated dust particles in long-term processes.

Food and beverages should be kept away from both the 3D printer and the 3D printed objects.

While operating Zortrax devices, all measures regarding health and safety provided in this User Guide as well as in separate regulations should be taken into account. .

Electrical Safety

Zortrax 3D printers have been tested for compliance with Low Voltage Directive. In order to ensure the highest safety standards, including protection against short circuit, overload, overvoltage, and printer overheating, do not attempt to modify the printer and do not use electronic replacement parts other than those recommended by the Manufacturer.

Replace electronic units according to the instructions and be particularly careful while using the tools supplied with the printer.

Before plugging the power cable into the outlet, make sure that the power supply voltage in the outlet matches the required value provided on the nameplate at the back of the printer. Avoid overloading the outlet with too many devices.

The printer must be well-grounded. Always make sure that the ground complies with local and national regulations.

Use only the original power cable supplied with the printer. Do not damage, cut or repair the cable. A damaged cable should be immediately replaced with a new one.

All maintenance and repair work should be carried out while the device is off and unplugged. Do not expose the device to moisture and liquids. Modifications, such as soldering of electronic subunits are forbidden.

Mechanical Safety

Zortrax 3D printers have movable components such as drive belts, extruder, or platform. Therefore, it is forbidden to reach into the printer or put anything inside the printer when it is running, about to start running or at rest. This may lead to serious injuries or damage.

Tools and accessories from the Starter Kit box should be used with special care only for intended purposes. Improper use of the tools may cause serious injuries.

While following post-processing procedures, wear safety gloves and glasses in order to avoid injuries that may be caused by sharp edges and fragile elements of the models.

Be particularly careful while removing the prints from the platform. Always wear safety gloves and glasses.

Risk of Burns







There is a high risk of burns while operating Zortrax printers as the extruder's temperature may reach up to 310° C [590° F]. Do not touch the extruder with bare hands. Be extremely careful during maintenance and repair work of heated units. If it is necessary to touch a heated component, use the pliers which are specially adapted for this purpose. Cooling of components should not take less than 30 minutes.

The platform's temperature can reach up to 105° C [221° F], therefore, special care should be taken while operating the printer and removing the finished prints.

Do not ignore the warning labels placed on the device.

Moreover, constructional modifications of the printer's operating temperature are not permitted as it may cause serious injuries or bring damage to the device.

Warning and Safety Labels on Zortrax Devices

	Due to design characteristics, the screws that secure the Z-axis screw nut cannot be fully tightened
	Wear safety gloves
	This symbol indicates that special care should be taken when repairing the device. Also, it points out an important step to be carried out
	The printer needs to be placed on a flat and stable surface to ensure proper quality of the prints
	Hot surface. Do not touch
	Do not reach into moving elements
	Unplug the main power cable before plugging and unplugging the heatbed cable connector

Safe Storage and Transport Guidance

Zortrax devices must be stored between 0 and 35° C [32 - 95° F]. The storage space should be free of moisture and other extreme conditions.

Transport Instructions

When stacking several devices on a pallet, follow the instructions provided on the packaging. One device may weigh more than 50 kg [110 lb]. It is therefore advisable to provide safe pallet storage, but not higher than 1.7 m [5' 7"]. It should be noted that the packages must not project beyond the outline of the pallet. Packages stacked on the pallet should be then bound together and wrapped in foil. The pallet prepared as above can be then forwarded to the shipping company.

Pallet stacking and destacking should be carried out by two people. The package with the device should be lifted or moved using special handles.

Electromagnetic Compatibility (EMC)

Each Zortrax printer complies with Part 15 of the FCC rules. Operation is subject to the following two conditions: (1) this device may not cause harmful interference, and (2) this device must accept any interference received, including interference that may cause undesired operation.

This equipment generates, uses, and can radiate radio frequency energy and, if not installed and used in accordance with this User Guide, may cause harmful interference to radio communications. Operation of this equipment in a residential area is likely to cause harmful interference, in which case the user will be required to correct the interference at his own expense.

Learn More About the Zortrax M300 Dual

The Zortrax M300 Dual together with Z-SUITE and dedicated materials constitutes the whole 3D printing ecosystem. Thanks to this device, it is possible to turn digital, three-dimensional projects into reality using the Layer Plastic Deposition Plus (LPD Plus) technology. This technology involves depositing layers of melted materials to build a predesigned shape. The device can work in both the dual-extrusion mode in which a 3D object is printed using a standard thermoplastic and a water-soluble support material, and in the single-extrusion mode in which a model and support structures are printed using the same material. In addition, the printer has several hardware features which significantly help to reduce the number of failed prints: the material jam detection system which immediately pauses the printing process

in the case of extrusion problems as well as the blackout response system which saves the printing progress so that the device can resume the printing from the same spot after a power outage. The Zortrax M300 Dual 3D printer can be used in many industries while designing and prototyping, for instance, automotive parts, mechanical elements, conceptual models, everyday objects as well as decorative elements.

How does the Zortrax M300 Dual work?

Everything begins with preparing a model. The work on the model can be started in any program which creates 3D models and generates .stl, .obj, .3mf or .dxf files. These are the standard file formats supported by most 3D modeling software - the model is saved as a set of three-dimensional triangles (triangle mesh).

The next step is to open the .stl file (or other) in Z-SUITE - the program created specifically for Zortrax devices. Z-SUITE prepares the model for 3D printing by slicing it into individual layers and saving it as a .zcodex file. Each layer represents the movement pattern of the extruder and the platform while building the whole object. Z-SUITE also allows you to choose the material types you want to use for the model and to adjust the necessary print settings, such as the size of the model, layer thickness, the type of infill or how many support structures should be generated. The file is then ready to be printed.

To start the printing process, turn the printer on, prepare and load the materials which correspond with the ones you have chosen in Z-SUITE. The full material offer is available at: <https://zortrax.com/filaments/>. While working with the M300 Dual, you can start, stop and pause the printing process in Z-SUITE. Once your file is prepared, you can transfer it from Z-SUITE to the printer's storage in two ways. You can either save the file on a USB flash drive and plug it into the port at the front of the printer or transfer the file from Z-SUITE over Wi-Fi/Ethernet cable. In addition, Z-SUITE allows you to add several printers to the program's panel and create a network of devices. This solution makes it possible to produce 3D models in a small series and manage the whole process from the screen of your computer. Each printer can still be operated using the touchscreen at the front.

What's in the Box



Zortrax M300 Dual
3D Printer



Material Spool
Holder (2 pcs)



Side Covers



Material Spool
(2 pcs)



Platform



Glass Plate



USB Drive &
WIFI Module



Z-SUITE &
Quick Start Guides



Safety Gloves &
Safety Glasses



Cutting Knife &
Scalpel



Allen Keys



Nozzle Key &
Nozzle Needle



Pliers



Spatula (2 pcs) &
Tweezers



Slotted
Screwdriver



Hotend Jig



Material Box



Material Guide
(3 pcs)



Service Grease



Power Cable

Main Components

1. Front view

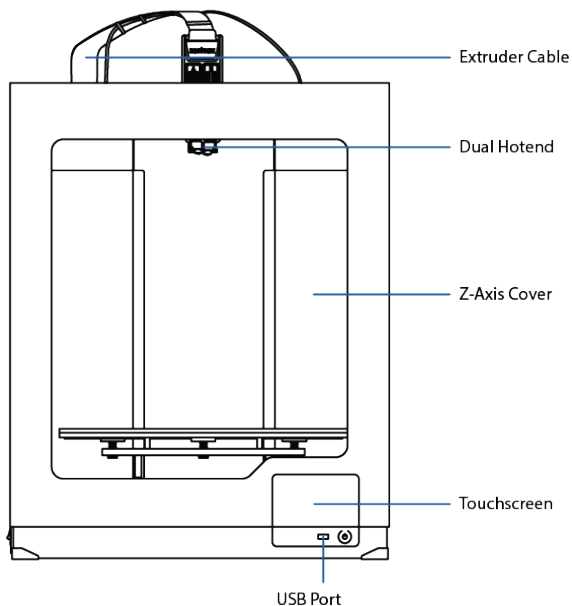

2. Back view

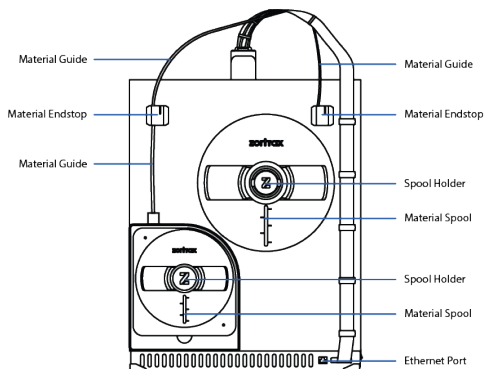

3. Left-side view

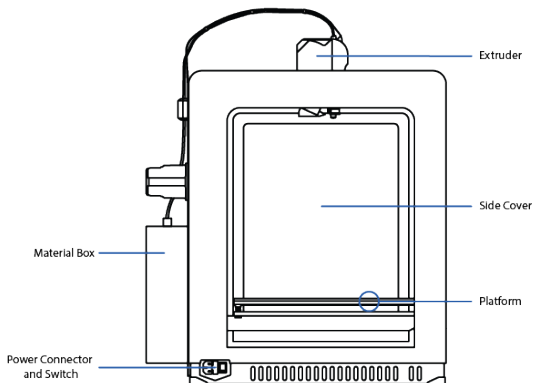

Zortrax 3D Printing Technology Glossary

BLACKOUT RESPONSE SYSTEM

a system which saves the printing progress in the device's internal storage so that it is possible to resume the printing from the same spot after a power outage.

EXTRUDER

the mechanism which ensures material feeding, heating and extruding as well as cooling of the print. Its main components include two hotends, each equipped with a nozzle, one for the model material and one for the support material. Each material is melted in the hotend, and then pushed through it until it exits the nozzle. The melted thermoplastic is deposited layer by layer to form a predesigned shape. Additionally, there are three fans on the extruder: one which cools the whole mechanism and two which cool the print.

EXTRUDER CABLE

the ribbon cable which connects the extruder with the motherboard. It supplies the extruder with electricity and allows the motherboard to regulate the printing process.

FIRMWARE

the software programmed into Zortrax printers, which controls and monitors all the data in the device. It also gives the possibility to enable/disable the printer's functions.

HOTEND

an essential heating system which consists of an aluminum block and a heater & thermocouple. The M300 Dual is equipped with two separate hotends, each adapted to print with a different material. The hotend is responsible for heating and melting the material as well as for ensuring proper temperature of the material during the whole printing process. In addition, the hotends are less likely to become dirty thanks to the teflon covers.

LPD Plus (LAYER PLASTIC DEPOSITION Plus)

a 3D printing technology which uses standard thermoplastics and a soluble support material to build parts. It involves depositing layers of the two materials to form a predesigned shape - an accurate representation of a digital model. The M300 Dual works in the LPD Plus technology, but the device can print objects in two modes: using only the

model material (single extrusion) or using both the model and the support material (dual extrusion). Depending on the chosen method, you have to remove the support structures manually or dissolve them in water.

MATERIAL BOX

the container with moisture absorbers placed at the back of the printer. It protects the support materials from external factors, including humidity, and helps to maintain high quality of prints.

MATERIAL ENDSTOP

a device which detects the presence of material and reacts when it runs out. The M300 Dual is equipped with two material endstops placed at the back of the printer. If during the printing process a spool of material is finished, the corresponding material endstop will automatically make the printer pause the printing and allow the user to load a new material.

MATERIAL GUIDE

the tube which feeds the material from the spool to the extruder at the proper angle. The M300 Dual is equipped with two material guides, both of which have to be attached to the extruder and to the corresponding material endstop placed at the back of the printer.

MATERIAL JAM DETECTION SYSTEM

a system thanks to which the device pauses the printing process and waits for the user's reaction every time either nozzle becomes clogged or the material gets tangled on the spool. Once extrusion problems are solved, the M300 Dual continues the printing. Thanks to that, the number of failed prints can be significantly lowered.

MATERIALS

specially dedicated Zortrax printing material which maximize the benefits of 3D printing. These thermoplastic materials are in the form of filaments wound on a spool. Zortrax offers a wide choice of materials, which are available at: <https://zortrax.com/filaments/>. Each material has different properties and can easily be adapted to a wide range of needs and applications. Moreover, most of the materials can be mechanically or chemically post-processed.

MOTHERBOARD

the most important part of every Zortrax printer, to which all the necessary components are connected. It is the main printed circuit board which makes it possible for other parts of the printer to communicate with each other. The motherboard is placed under the bottom plate, along with the cooling fan and the power supply unit.

NOZZLE ALIGNMENT CALIBRATION

one of the maintenance procedures that needs to be carried out before the first and every longer print. It involves printing two trial models, each with lines printed with the support material on top of lines printed with the model material. The user has to inspect both models visually and choose the pair of lines where the support material covers the model material most precisely. The nozzle alignment calibration regulates the position of the hotends in order to achieve the best accuracy during the printing process.

NOZZLE

the narrow piece attached to each of the two hotend. It is used to direct a flow of material throughout the entire printing process, allowing to form the desired shape of a model.

PLATFORM

an integral part of the 3D printer, on which the model is created. It consists of two parts: the heatbed and the perforated plate. Both parts are connected together with the use of screws and Pogo pins. The heatbed provides proper platform heating, whereas the perforated plate increases adhesion of the model to the platform surface. Additionally, you can use the glass plate which is included in the set. It is adapted for raffleless 3D printing which provides a better quality of bottom surface in your models. The whole platform can easily be removed or put back in place.

PLATFORM CALIBRATION

a procedure which lowers the risk of issues that may occur during the printing process. It involves checking the distance between the two nozzles and five points on the platform, and tightening/loosening the calibration screws. You can calibrate the platform in two ways: automatically or manually. In both cases, follow the instructions displayed on the printer's screen.

POWER OUTLET AND MAIN SWITCH

the switch enables tuning the printer on and off. Next to the switch, there is a power outlet where you plug the power cable in.

SIDE COVERS

plastic panels that can easily be attached to the housing of the printer. They have been designed to provide protection from drafts and temperature differences that can occur in the printing room. Constant temperature inside the printing chamber is important for avoiding cracks and warping of prints. The side covers protect the model during the printing process and help it to adhere better to the platform. The set of covers consists of: two side covers, one front cover, magnets, and hinges. The front panel is fixed to the housing with two hinges and closed by hidden magnets, whereas the side panels snap on. We especially recommend using the side covers for large-sized prints and prints made of materials with high or medium shrinkage level, like Z-ABS.

SPOOL HOLDER

the element which is used to secure a spool of material at the back of the printer. There are two types of spool holders in the M300 Dual: one which secures the model material spool and one which secures the support material spool

STARTER KIT

several pieces of equipment that are put together in on set. Apart from the heatbed, the perforated plate and the glass plate, the set contains tools and protective equipment. The Starter Kit is needed to perform maintenance and repair work of your Zortrax printer. Each printer is delivered with equipment including, for example, a set of nozzle keys or safety gloves.

SUPPORT STRUCTURES

if your model has any overhanging or protruding sections, they have to be supported with additional structures so that the whole model doesn't fall down and lose its predesigned shape during the printing process. The support can be printed with the same material as the model or the special water-soluble support material. Once the printing is done, you have to remove the support structures manually or dissolve them in water.

TOUCHSCREEN

the display screen placed at the front of the printer, which enables fast and intuitive navigation through the device's menu. The screen also displays information about the current printing process and other information concerning the printer.

WASTE TOWER

a simple element which is printed next to the model during the dual-extrusion printing process. Every time the printer switches from printing with the model material to the support one and vice versa, the respective nozzle has to be either emptied or filled with material. That's why, the waste tower is gradually built with one layer before changing the material and afterwards. As a result, the two materials do not blend on the surface of the print and at the same time there are no material deficiencies.

Z-AXIS SCREW

the screw which is responsible for the platform's vertical motion. It is driven by the stepper motor placed under the bottom plate. The Z-axis screw constitutes an integral part of the platform moving system.

ZCODEX

a file format which contains a model prepared for 3D printing with previously selected print settings, such as layer thickness, infill type, etc. All print settings can be managed in Z-SUITE before generating the .zcodex. The .zcodex format can be transferred to the printer directly from Z-SUITE over Wi-Fi/Ethernet cable or using a USB flash drive. This format can only be created by processing .stl, .dxf, .obj, or .3mf files in Z-SUITE.

ZORTRAX HEPA COVER

a filtering device which consists of an acrylic glass frame, a filter module, and a fan. The HEPA Cover is attached to the top of the printer and therefore helps to resolve several common problems connected with 3D printing in the FDM/FFF technology. Users are able to regulate the temperature inside the chamber, which is very important while printing with high shrinkage materials, like ABS or ABS-based filaments. There are two replaceable filters installed in the device: HEPA and carbon, both of which eliminate unpleasant smells of melted material and filter over 99% of particles that are released during the 3D printing process. The fan speed can be adjusted with the use of a knob - lower speed ensures better warping protection, whereas higher speed provides better air filtration.

Z-SUITE

the application created specifically for Zortrax devices. Z-SUITE prepares a model for 3D printing by generating the file in the .zcodex format. Z-SUITE allows the users to change and adjust the print settings, such as the size of the model, layer thickness, the type of infill, or how many support structures will be generated. Once the .zcodex is generated, the print settings cannot be changed. The last step is to transfer the file to the printer's storage using Wi-Fi, Ethernet cable, or a USB flash drive.

First Use Preparation

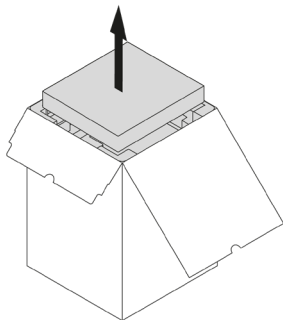

1. Open the box. Remove the upper cushioning and boxes with accessories.

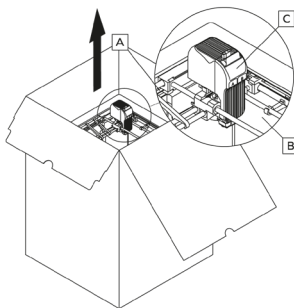

2. Take the 3D printer out of the box. When lifting or moving the printer, do not grab:
a. drive belts; b. shipping clips; c. extruder.

*Due to the printer's weight, Zortrax M300 Dual should be taken out of the box or moved by two people.

zortrax

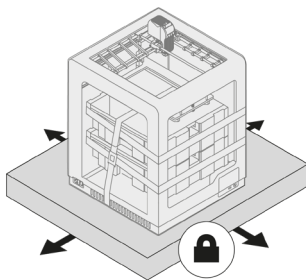

3. Place the printer on a flat and stable surface.

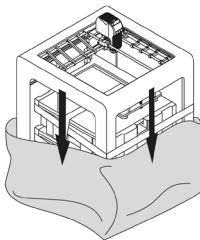

4. Remove the foil.

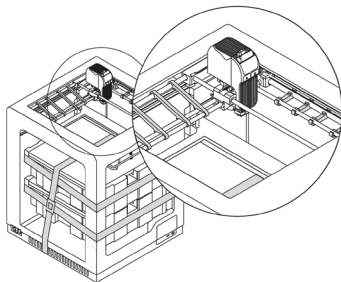

5. Remove the shipping clips and the belts securing the foams with accessories.

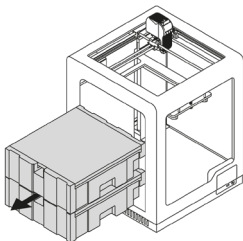

6. Remove the foams with accessories.

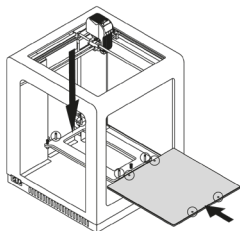

7. Lower the heatbed mount by pressing the place marked with an arrow. Next, install the build platform onto the bolts marked in the graphic. Remember to install the platform with the perforated plate directed up.

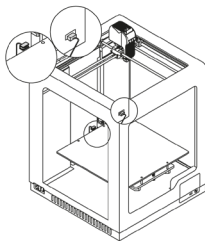

8. Plug the heatbed cable into the platform and into the adapter placed in the Z-axis cover.

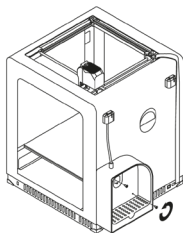

9. Unpack the material box and secure it to the back of the printer with the two screws. Place two moisture absorbers under the grid inside the material box. Next, attach the material guide to the material B endstop.

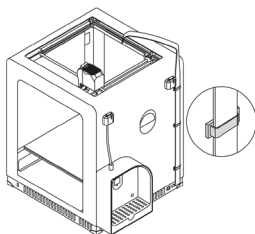

10. Attach the extruder cable clamps at the back of the printer. Place the extruder cable in the clamps.

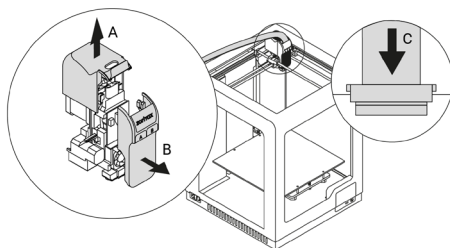

11. Remove the extruder top cover by pulling it upwards (A) and then remove the front cover (B). Plug in the extruder cable (C). Place the front cover back in its place and reattach the top cover.

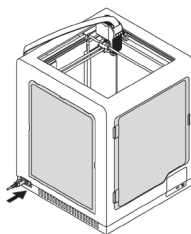



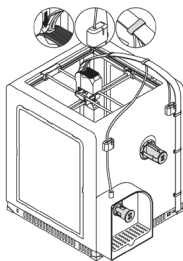

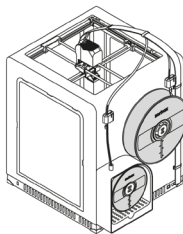

12. Remove the protective cap from the camera inside the printer. Next, install all side covers. For more details, see the manual: <https://support.zortrax.com/side-covers-installation/>. Next, plug in the power cable.











13. Attach the two spool holders at the back of the printer. Next, attach the two material guides to the extruder and to the material endstops. Secure the two guides to the extruder cable using the material guide clamps.









14. Place the spools on the holders. The spools should rotate anti-clockwise. Feed the materials into the extruder through the material endstops and the material guides.

	TOOLS	
	MATERIALS	>
	PLATFORM	>
	HEAT EXTRUDER	
	NOZZLE ALIGNMENT	>
	MANUAL TEST	

	< PLATFORM	
	PERFORM OFFSET	>
	HEAT PLATFORM	>
	MOVE PLATFORM	
	MANUAL CALIBRATION	
	AUTOCALIBRATION	

15. To calibrate the platform, select *Tools*, *Platform*, and then *Autocalibration* or *Manual Calibration* (requires preparing paper in the A4 size) from the menu. Follow the instructions displayed on the screen.





	TOOLS	
	MATERIALS	>
	PLATFORM	>
	HEAT EXTRUDER	
	NOZZLE ALIGNMENT	>
	MANUAL TEST	







16. Load the material using options from the *Materials* menu. Next, carry out the *Nozzle alignment calibration*. Follow the instructions displayed on the screen.

Connecting the printer to a network

The M300 Dual can be connected to a local network in two ways: via Wi-Fi or an Ethernet cable. Both methods allow you to manage the printer directly from Z-SUITE and make it possible to remotely transfer .zcodex files from your computer to the printer.

To connect the printer to a Wi-Fi network, open the *Settings* menu and select *Wi-Fi*. From the list of available networks, choose your network and if it's required, enter the password. Select *Connect* to establish the connection.

	SETTINGS
	WI-FI off >
	ETHERNET off >
	FILE SORTING >
	LANGUAGE English >
	WORKING OPTIONS >

< WI-FI	
NETWORK_1	 
NETWORK_2	 
NETWORK_3	 

< NETWORK_1	🔒 📶
MAC address	aa:bb:cc:dd:ee:ff
Password	👁️ Enter password
MANUAL IP	on <input checked="" type="checkbox"/>
IP ADDRESS	192.168.0.1
CONNECT	

To connect the printer with an Ethernet cable, create a local network and connect the router/modem/switch to the printer. The connection will be established automatically. You can control the Ethernet connection settings in the main menu; select *Settings* and *Ethernet*.

	SETTINGS
	WI-FI off >
	ETHERNET off >
	FILE SORTING >
	LANGUAGE English >
	WORKING OPTIONS >

< ETHERNET	on <input checked="" type="checkbox"/>
MAC ADDRESS	aa bb cc dd ee ff
MANUAL IP	on <input checked="" type="checkbox"/>
IP ADDRESS	192.168.0.1
SUBNET MASK	255.255.255.0
DEFAULT GATEWAY	192.168.0.1

Once your printer is connected to the network, open the *My Devices* panel in Z-SUITE. You can search for devices available in the local network and add them to the program's panel. Select the icon with your printer's IP address and click on it to add the printer to the panel. You can also add a printer manually by typing its IP address.

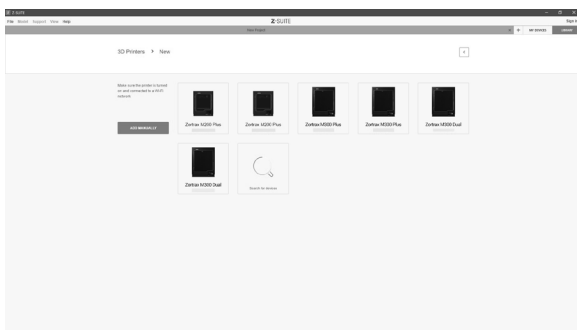
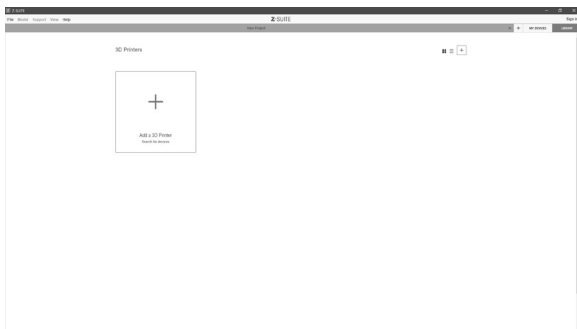

Each added printer can easily be managed in Z-SUITE. You can start, stop, and pause the printing process, see the printer's current state (*Ready to Print / Printing / Paused / Offline*), change the name of your printer, preview basic information about the printer, or display the preview from the printer's camera.

In the *3D Printer Files* tab, you can preview all .zcodex files that are stored on the printer's USB flash drive.

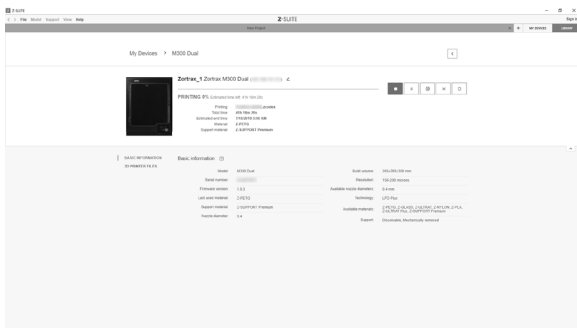

Firmware Update

If your printer is connected to the Internet using either Wi-Fi or an Ethernet cable, it automatically checks for available firmware updates. Every time you turn on the printer, you will see the launcher displaying information about the current firmware version and whether the firmware can be updated. Once you get this notification, follow the instructions displayed on the screen.

You can also check if there is an available firmware update using options from the menu. Open the *Settings* menu and select *About printer*, and then *Check for updates*.

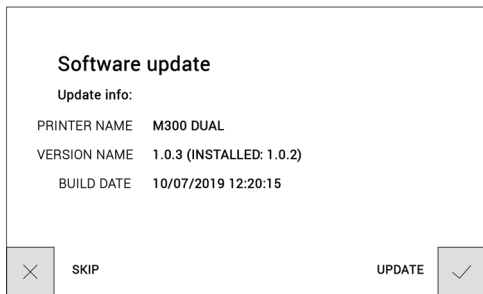

If you have decided not to connect the printer to the Internet, check <https://support.zortrax.com/download/> regularly for updates. To update the firmware, transfer the Update.zar file to a USB flash drive and plug it into the port at the front of the device. To start the installation, select *Refresh*.

Navigating through the Menu

The printer's functions can be activated or deactivated through the options available in the menu.

The main menu is divided into three submenus: TOOLS, SETTINGS and PRINT. The main menu also displays basic information about the printer: the printer's IP address, the type of connection to a local network (Wi-Fi or Ethernet), the materials loaded into the extruder, and storage used on the USB flash drive.

TOOLS: this menu contains options that are useful during the printing process and maintenance work connected with the printer's main components:

Materials: this menu contains options which allow you to load and unload the materials used for printing.

Platform:

Platform offset - this option allows you to set the platform at the correct distance from the two nozzles.

Heat platform - this option heats up the platform to operating temperatures. It can be useful while performing platform maintenance work.

Move platform - this option allows you to change the position of the platform.

Manual calibration - this option activates the procedure of manual calibration.

Autocalibration - this option activates the procedure of automatic calibration.

Heating the extruder - this option heats up the extruder to operating temperatures. It is useful while replacing the nozzles and performing other extruder maintenance activities.

Nozzle alignment - this option activates the procedure of nozzle alignment calibration which sets the correct position of the hotends.

Run lower fan / Run upper fan - these options allow you to check the extruder fans for proper operation.

SETTINGS:

Wi-Fi - this tab shows all available Internet networks and allows you to connect the printer to the chosen network.

Ethernet - this tab allows you to control the Ethernet connection settings.

File sorting - this option allows you to organize saved models by the date and time of saving, or by the file size.

Language - this tab allows you to choose the language of the menu and printer messages.

Working options: this tab contains several options you can use to configure the printer's operation:

Hotend switch calibration - this option activates the hotend switch calibration. The calibration involves setting the extruder's position manually in relation to the hotend switch (both model and support).

Buzzer - this option enables/disables the sounds in the device.

Full platform preheating - when this option is enabled, the printer starts every printing process only when the platform is fully heated up.

Ignore material endstop - this option allows you to print without having to use one or two of the material endstops.

Ignore hotend material jam - when this option is enabled, the printer will not enter the pause mode in the case of blockages in the nozzles.

About printer - this tab contains information which identifies the printer model, its firmware and hardware version, serial number and total printing time.

PRINT: this tab shows all models saved on the USB flash drive. You can store all of your files in one or several folders. Here you can select a model for printing.

Material Loading

Select *Tools* and *Materials*. Next, select which material you want to load and click *Load*. At this point the printer will start to heat up the extruder.

WARNING! The extruder will be hot. Don't touch it. Wear safety gloves.

Once heating is completed, install the spool on the holder at the back of the printer, feed the material into the extruder through the material endstop and the material guide.

Follow the instructions displayed on the screen.

Loading of the model and the support materials is performed in the same way, but using adequate options from the menu.

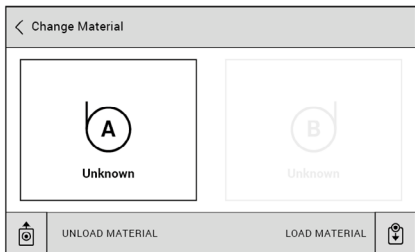
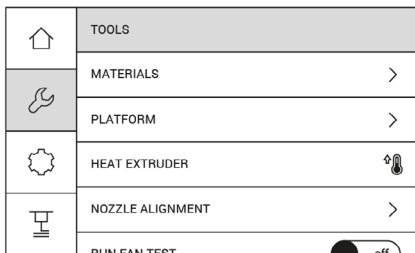

zortrax

< MATERIAL
Z-ABS
Z-ULTRAT
Z-ULTRAT PLUS
Z-GLASS
Z-HIPS

 Change material

 Z-ULTRAT Warning! Extruder is hot.

Heating **95%**

 STOP

 Change material

 Z-ULTRAT Warning! Extruder is hot.

Material loaded successfully

DONE 

Platform Calibration

Platform calibration is a procedure which lowers the risk of issues that may occur during the printing process. It involves a procedure of checking the distance between the nozzle and five points on the platform, and tightening/loosening the calibration screws. You can calibrate the platform in two ways: automatically or manually. In both cases, follow the instructions displayed on the printer's screen.

WARNING! The extruder will be hot during the calibration. Don't touch it. Wear safety gloves.

Automatic calibration

Open the *Tools* menu and select *Platform*, and *Autocalibration*.

The printer will lift up the platform and display a message indicating that the three calibration screws placed under the platform need to be tightened. Once you've tightened the screws, select *Done* to continue.

Next, the printer will start to check the distance between the nozzle and five points on the platform: two at the front, two at the back, and one in the center of the platform.

If the printer detects an incorrect distance in any of these points, the display will show instructions on what adjustments should be made. Follow the instructions and tighten or loosen the screw indicated in the message. Once you finish, select *Done* and the printer will recheck a given point on the platform.

If the distance between the nozzle and five points is set within the acceptable limits, the printer will finish the calibration procedure. Additionally, the display will show the calibration results. Select *Done* to finish the calibration.

Manual calibration

Open the *Tools* menu and select *Platform*, and then *Manual Calibration*. The printer will lift up the platform and display the first message containing instructions on manual calibration.

Step 1: push the UP button until the platform is about 1 mm from the nozzle.

Step 2: rotate the back left screw until the platform is about 1 mm from the nozzle.

Step 3: rotate the back right screw until the platform is about 1 mm from the nozzle.

At this point you have to prepare a sheet of paper in the A4 size.

Step 4: place the paper between the platform and the nozzle. Next, adjust the platform's distance using the UP/DOWN buttons until you feel slight resistance when moving the paper.

Step 5: rotate the back left screw until you feel slight resistance when moving the paper.

Step 6: rotate the back right screw until you feel slight resistance when moving the paper.

Next, the printer will display a message containing instructions on calibrating the platform in relation to the second nozzle.







Step 7*: place the paper between the platform and the nozzle. Adjust the platform's distance using the UP/DOWN button until you feel slight resistance when moving the paper.

*Follow this step only when you have trouble with default calibration values.

Nozzle Alignment Calibration

Nozzle alignment calibration is one of the maintenance procedures that needs to be carried out before the first and every longer print. It involves printing two trial models, each with lines printed with the support material on top of lines printed with the model material. The user has to inspect both models visually and in each model choose the pair of lines where the support material covers the model material most precisely. The nozzle alignment calibration regulates the position of the hotends in order to achieve the best accuracy during the printing process.

You need to carry out the platform leveling before commencing the nozzle alignment calibration.

	TOOLS	
	MATERIALS	>
	PLATFORM	>
	HEAT EXTRUDER	
	NOZZLE ALIGNMENT	>
	RUN CLEAN TEST	

1. From the main menu select *Tools* and *Nozzle Alignment*.

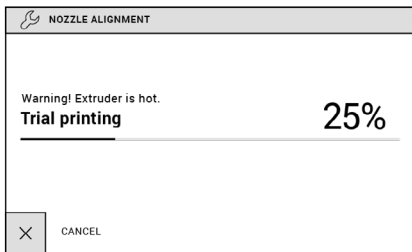
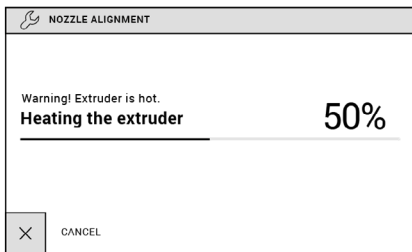
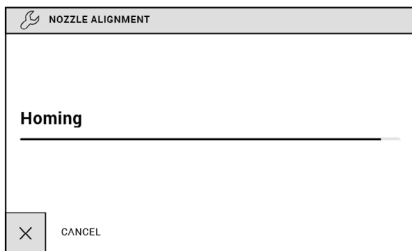

2. At this point the printer will start to heat up the hotends, and then print two trial models.

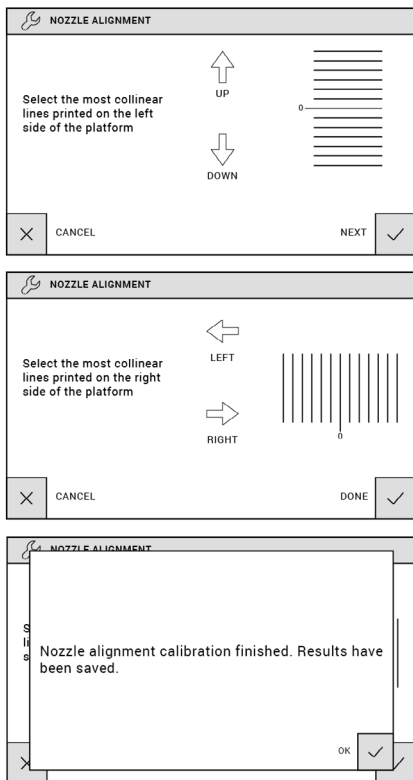

3. Inspect both models visually. From each model select the most collinear lines printed (the lines where the support material covers the model material most precisely). Select *Done* to finish the calibration.

Z-SUITE Installation

The latest Z-SUITE update can be found in the *Download* section at: <https://support.zortrax.com/>. To download and install Z-SUITE, you can enter the serial number of your printer or your email address. The serial number can be found in the printer's menu: *Settings* -> *About Printer*, and on the nameplate at the back of the printer.

Remember to update Z-SUITE regularly. All updates are available at: <http://support.zortrax.com/download/>.

Starting and Removing a Print

Once you have saved your model as a .zcodex file, you need to transfer it to the printer's storage. There are two ways to do it: you can either save the file on the USB flash drive and plug it into the port at the front of the printer, or you can transfer the file directly from Z-SUITE over Wi-Fi/Ethernet cable.

To start the printing process, open the *My Devices* tab in Z-SUITE and select the printer you want to work with. Next, open the *3D Printer Files* and from all models saved in the printer's storage select the one you want to print and click the *Print* button.

You can also use the options from the main menu to print your model. Open the *Print* tab and from all models select the one you want to print and tap *Print*.

At this point the printer will start to heat up the extruder.

WARNING! The extruder will be hot. Don't touch it. Wear safety gloves.

The printing process will start automatically.

Remove the print very carefully because there are some elements of the printer that can get damaged during the process. The following instructions show the correct procedure of removing the print from the platform.

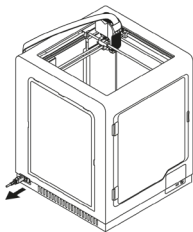

1. Turn off the printer and unplug the power cable.

WARNING! WAIT 30 MINUTES UNTIL THE PLATFORM AND THE PRINT COOL DOWN.

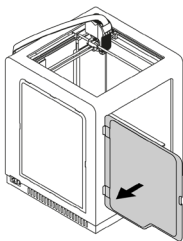

2. Open the front cover.

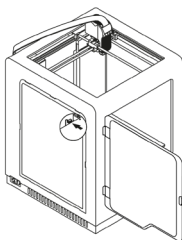

3. Unplug the heatbed cable from the platform.

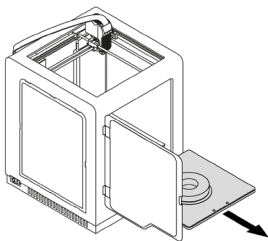

4. Remove the platform from the printer.

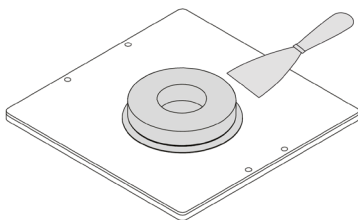

5. Use a spatula to remove the print.

WARNING! REMOVE THE PRINT VERY CAREFULLY. WEAR SAFETY GLOVES.

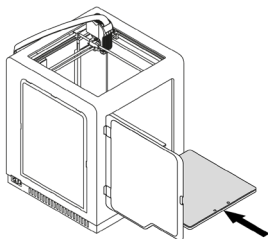

6. Put the platform back in the printer.

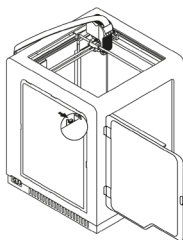

7. Plug in the heatbed cable.

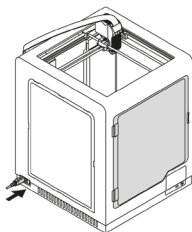

8. Close the front cover and plug in the power cable.

NOTE! ONCE THE PRINTING PROCESS IS FINISHED AND YOU DON'T PLAN TO START THE NEXT PRINT, UNLOAD THE MATERIAL AND TAKE THE SPOOL OFF OF THE SPOOL HOLDER. SECURE THE END OF THE MATERIAL AS IT IS SHOWN IN THE PICTURE TO AVOID HAVING TANGLED THREADS OF MATERIAL ON THE SPOOL. THIS APPLIES TO BOTH THE MODEL AND THE SUPPORT MATERIAL.

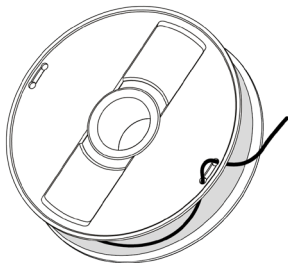

Available Materials

The complete offer of materials is available at: <https://zortrax.com/filaments/>. *Material Technical Data Sheets* and *Safety Data Sheets* can be found on the same website.

When 3D printing with Zortrax devices, the Manufacturer recommends using Zortrax certified materials to acquire the best possible quality of prints.

Basic Maintenance and Service Work

Maintenance work should be regular in order to keep the printer in good condition and achieve high quality prints every time. Some parts require maintenance before each print and some every few hundred working hours. All maintenance activities do not take much time and are not complicated. Before commencing any repair, it is extremely important to turn off the printer and let it cool down. Remember to always wear safety gloves and glasses.

The printer is delivered with a full set of tools needed to carry out maintenance and service work.

The following tables present maintenance and repair guidelines connected with each section of the M300 Dual, together with specific check points, necessary activities and their frequency.

1. Main

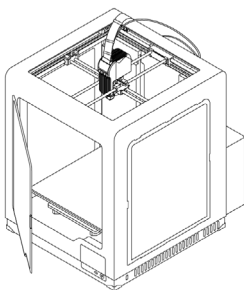

Activity	Frequency	Solutions to the problems	Necessary accessories
Cleaning the machine, its interior and surroundings, especially the bottom plate under the platform	Before each printing	The user is responsible for keeping the machine clean. To remove material remains from the interior of the device, use a vacuum cleaner or compressed air	- a vacuum cleaner, - cleaning products with a high evaporation rate

ⓘ Lack of proper care of the machine can cause inadvertent damage or improper operation of the drive units

2. Hotends

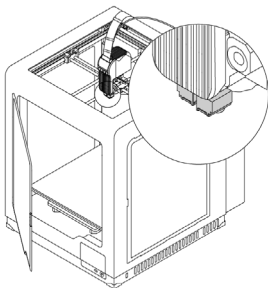

Activity	Frequency
Checking if the hotends and nozzles are not clogged	Before each printing
Cleaning the nozzles	After finishing one spool of material
Checking if the screws that secure the heater and thermocouple are tightened (in both hotends)	Every 300 working hours

- ① Lack of proper care of the machine can cause inadvertent damage or improper operation of the drive units

3. Platform

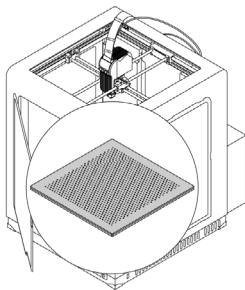

Activity	Frequency	Solutions to the problems	Necessary accessories
Cleaning the perforated plate	Before each printing	To remove material remains from the surface of the perforated plate, use a spatula	- a spatula
Checking the perforated plate for deformation	Before each printing	-	-
Calibration	Every 200 working hours	If the platform calibration fails, move on to the next step indicated in this table	-
Cleaning the heatbed and the underside of the perforated plate	Every 300 working hours	Unscrew the screws that secure the perforated plate and remove the residues from the underside of the plate using a spatula. The heatbed needs to be cleaned with a piece of cloth damped in acetone	- a spatula, - a piece of cloth, - acetone
Checking if the clips that secure the glass plate to the heatbed are properly installed and if the screws that secure the clips are tightened.	Every 200 working hours	-	- a 2 mm Allen key

ⓘ Lack of proper care of the machine can cause inevent damage or improper operation of the drive units

4. X/Y axes; extruder guide rails

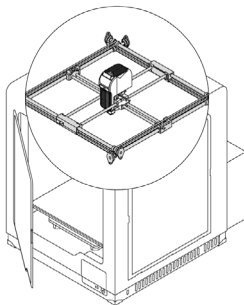

Activity	Frequency	Solutions to the problems	Necessary accessories
Checking if the axes and the extruder guide rails are clean from material remains and dust	Before each printing	It is possible to feel slight resistance while checking if the extruder moves freely on the guide rails. In such case you should check if the X/Y axes and the extruder guide rails are covered with black grime. The axes and guide rails should be cleaned with a cloth damped in acetone and then lubricated with grease supplied in the Starter Kit	-
Checking the tension of the drive belts on the X/Y axes	Every 500 working hours	In order to check the tension of the drive belts on the X/Y axes, move the extruder to the central point and gently tug the belts. If the belts are loosened, tighten the screws placed on the top part of the X/Y axes blocks	-
Checking the tension of the drive belts between the motors and the X/Y axes	Every 500 working hours	-	-
Checking if the screws on the X/Y axes and the motors pulleys are tightened	Every 300 working hours	-	-

Activity	Frequency	Solutions to the problems	Necessary accessories
Checking if the extruder moves freely when the printer is off	Every 300 working hours	-	-
Lubricating the X/Y axes and the extruder guide rails	Every 200 working hours	-	- teflon grease

- ① Lack of proper maintenance of the X/Y axes can influence the final look of the print and cause the effect of shifted layers. Cleaning and lubricating the axes can help you save the material used for 3D printing as well as the time for preparing the device for printing

5. Extruder

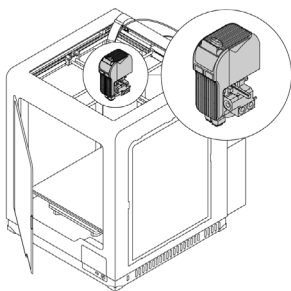

Activity	Frequency
Checking if the extruder top cover and material guides are properly installed	Before each start-up of the printer
Checking if both material guides are properly secured to the extruder cable with the material guide clamps	Before each start-up of the printer
If you use the HEPA Cover, check if it does not press the extruder cable	Before each start-up of the printer

Activity	Frequency
Checking if the extruder cable is properly plugged into the extruder PCB	Every 300 working hours
Checking if the extruder PCB is properly secured to the extruder block	Every 300 working hours
Checking if the pins on the extruder cable connector are clean	Every 300 working hours
Checking if the screws that secure the hotends are not loose and, if necessary, tightening them	Every 300 working hours
Removing the material remains and lumps from the extruder	Every 300 working hours
Checking if the fans are working	Every 300 working hours

 Lack of proper care of the machine can cause inevent damage or improper operation of the drive units

Support and Troubleshooting

In order to ensure safety of every 3D printer's user, the Manufacturer provides various support while identifying and solving technical problems independently.

In case of difficulties with operating a Zortrax 3D printer, at first you should seek guidance in this User Guide, check the manuals available at: <http://support.zortrax.com/>, or consult our technical specialists through the Support Form available at: <http://support.zortrax.com/support-form/>.

The most common problems are listed below along with the list of possible solutions.

The printer does not load the material into the extruder or the material is not extruded from the nozzle (applies to both materials and nozzles):

1. Check if the material is not tangled on the spool or blocked near the inlet of the material endstop. If so, unload the material using options from the menu. Cut off the tangled or blocked fragment of the material. Reload the material and restart the printing process.
2. Check if the spool is properly secured on the spool holder. The spool may not be able to rotate if it has been installed incorrectly.

3. Make sure that the material is not faulty or irregular, that is, it does not have swells on its surface. If so, unload the material using options from the menu. Use a different spool.
4. Make sure that the end of the material loaded into the extruder has been cut at a right angle. Cut the end of the material at an acute angle to make material loading easier.
5. For further help, visit our Support Center at: <http://support.zortrax.com/>.

The print cracks and does not adhere to the platform (it warps):

1. If the print does not adhere to the platform:

- carry out platform calibration again,
- make sure that the side covers are installed,
- make sure that the model is correctly designed and arranged in the workspace,
- try adjusting the print settings differently by changing the level of infill and the model's arrangement in the workspace,
- provide proper temperature in the printing room, before starting the printing process, make sure that the platform is sufficiently clean.

2. If the print cracks:

- make sure that the side covers are installed,
- make sure that the model is correctly designed and arranged in the workspace,
- try adjusting the print settings differently by changing the level of infill and the model's arrangement in the workspace,
- provide proper temperature in the printing room.

3. For further help, visit our Support Center at: <http://support.zortrax.com/>.

Error Messages

Whenever there is a technical issue caused by a hardware failure, negligence, or inappropriate use of Zortrax printers, the firmware immediately displays an error message on the screen. The following list explains all error messages and provides potential causes and suggested solutions.

Error Number	Potential Cause	Suggested Solution
#1	Upper fan: Not working	-Select the <i>Run upper fan</i> option from the menu and check if the fan is working - If the fan is not working: 1) ensure that the fan's blades are not mechanically blocked, 2) check if the fan is properly connected to the extruder PCB 3) upper fan replacement
#2	Bottom fan: Not working	-Select the <i>Run bottom fan</i> option from the menu and check if the fan is working - If the fan is not working: 1) ensure that the fan's blades are not mechanically blocked, 2) check if the fan is properly connected to the extruder PCB 3) bottom fan replacement
#2:1	Left Hotend: Critical temperature	-Check if the heater&thermocouple are properly installed and secured in the hotend -Check if the extruder cable is properly connected -Heater&thermocouple replacement -Extruder cable replacement -Extruder PCB replacement
#2:2	Left Hotend: Temperature drop	-Check if the heater&thermocouple are properly installed and secured in the hotend -Check if the extruder cable is properly connected -Heater&thermocouple replacement -Extruder cable replacement -Extruder PCB replacement

zortrax

Error Number	Potential Cause	Suggested Solution
#2:3	Left Hotend: Sensor Failure	<ul style="list-style-type: none"> -Check if the heater&thermocouple are properly installed and secured in the hotend, -Check if the extruder cable is properly connected, -Heater&thermocouple replacement, -Extruder cable replacement, -Extruder PCB replacement
#2:4	Left Hotend: Heater failure	<ul style="list-style-type: none"> -Check if the heater&thermocouple are properly installed and secured in the hotend -Check if the extruder cable is properly connected -Heater&thermocouple replacement -Extruder cable replacement -Extruder PCB replacement
#2:10	Left Hotend: Temperature fluctuation	<ul style="list-style-type: none"> -Check if the heater&thermocouple are properly installed and secured in the hotend -Check if the extruder cable is properly connected -Heater&thermocouple replacement -Extruder cable replacement -Extruder PCB replacement
#3:1	Right Hotend: Critical temperature	<ul style="list-style-type: none"> -Check if the heater&thermocouple are properly installed and secured in the hotend -Check if the extruder cable is properly connected -Heater&thermocouple replacement -Extruder cable replacement -Extruder PCB replacement
#3:2	Right Hotend: Temperature drop	<ul style="list-style-type: none"> -Check if the heater&thermocouple are properly installed and secured in the hotend -Check if the extruder cable is properly connected -Heater&thermocouple replacement -Extruder cable replacement -Extruder PCB replacement

zortrax

Error Number	Potential Cause	Suggested Solution
#3:3	Right Hotend: Sensor Failure	<ul style="list-style-type: none"> -Check if the heater&thermocouple are properly installed and secured in the hotend, -Check if the extruder cable is properly connected, -Heater&thermocouple replacement, -Extruder cable replacement, -Extruder PCB replacement
#3:4	Right Hotend: Heater failure	<ul style="list-style-type: none"> -Check if the heatbed cable is properly connected to the heatbed -Check if the heated cable is properly connected to the motherboard -Heatbed cable replacement -Heatbed cable adapter replacement
#3:10	Right Hotend: Temperature fluctuation	<ul style="list-style-type: none"> -Check if the heater&thermocouple are properly installed and secured in the hotend -Check if the extruder cable is properly connected -Heater&thermocouple replacement -Extruder cable replacement -Extruder PCB replacement
#4:1	Platform Heating Plate: Critical temperature	<ul style="list-style-type: none"> -Check if the heatbed cable is properly connected to the heatbed -Check if the heatbed cable is properly connected to the motherboard -Heatbed cable replacement -Heatbed cable adapter replacement
#4:2	Platform Heating Plate: Temperature drop	<ul style="list-style-type: none"> -Check if the heatbed cable is properly connected to the heatbed -Check if the heatbed cable is properly connected to the motherboard -Heatbed cable replacement -Heatbed cable adapter replacement

zortrax

Error Number	Potential Cause	Suggested Solution
#4:4	Platform Heating Plate: Heater failure	<ul style="list-style-type: none"> -Check if the heatbed cable is properly connected to the heatbed -Check if the heatbed cable is properly connected to the motherboard -Heatbed cable replacement -Heatbed cable adapter replacement
#4:10	Platform Heating Plate: Temperature fluctuation	<ul style="list-style-type: none"> -Check if the heatbed cable is properly connected to the heatbed -Check if the heatbed cable is properly connected to the motherboard -Heatbed cable replacement -Heatbed cable adapter replacement
#5:5	Endstop X: Homing failure	<ul style="list-style-type: none"> -Check if the X-axis endstop is properly connected -Make sure that the metal strip installed on the axis block enters the endstop -Carry out X/Y axis maintenance -X-axis endstop replacement
#6:5	Endstop Y: Homing failure	<ul style="list-style-type: none"> -Check if the Y-axis endstop is properly connected -Make sure that the metal strip installed on the axis block enters the endstop -Carry out X/Y axis maintenance -Y-axis endstop replacement
#7:5	Bottom Endstop Z: Homing failure	<ul style="list-style-type: none"> -Ensure that nothing is blocking the platform while it is moving to the very bottom -Check if the Z-axis endstop is properly connected -Z-axis endstop replacement
#8	Unable to communicate with the control board	<ul style="list-style-type: none"> -Check the connection between the Android board and the motherboard -Contact your Reseller/ Distributor
#11:3	Cap Sensor: Sensor failure	<ul style="list-style-type: none"> -Check if the capacitive sensor is properly connected to the extruder PCB and installed in the fan shroud

zortrax

Error Number	Potential Cause	Suggested Solution
#15:8	Extruder PCB: No connection	-Check if the extruder cable is properly connected -Extruder cable replacement -Extruder PCB replacement
#15:11	Extruder PCB: Overheating	-Check if the ambient temperature does not exceed 30° C [86° F] -If the ambient temperature is higher than 30° C [86° F], turn the printer off and unplug the power cable. Wait until the temperature falls below the recommended value. -Extruder PCB replacement -Contact your Reseller/ Distributor
#16:12	Power Supply: Overheating	-Turn the printer off and unplug the power cable -Contact your Reseller/ Distributor
#17:13	Motherboard: Overheating	-Turn the printer off and unplug the power cable -Contact your Reseller/ Distributor
In the case of other error messages, contact Zortrax Customer Support through the Support Form and provide details and pictures.		

	<p>If the device begins to operate in an unidentified way, safely unplug the printer from the power supply and immediately contact the Support Center specialists via the support form at: http://support.zortrax.com/support-form/.</p>
	<p>While shipping the device to the Manufacturer's technical service, it is important to properly prepare a package. Use the original packaging. Detailed instructions on how to pack the device are available at: https://support.zortrax.com/m300-dual-packing/.</p>

More manuals and tips & tricks articles are available at our Support Center.

www.zortrax.com

Specification

Device	
Build Volume	265 x 265 x 300 mm [10.4 x 10.4 x 11.8 in]
Nozzle Diameter	0.4 mm [0.016 in]
Extruder	Dual, printing with model and support material
Extruder Cooling System	Two fans cooling the extruder block; radial fan cooling the print
Hotend	Dual
Platform	Heated; perforated and glass plates are applicable
Material Endstop	2 x Mechanical
Connectivity	Wi-Fi, Ethernet, USB
Operating System	Android
Processor	Quad Core
Touchscreen	4" IPS 800 x 480
Camera	Yes
Printing	
Technology	LPD Plus (Layer Plastic Deposition Plus) - depositing melted material layer by layer onto the build platform with dissolvable support structures
Layer Resolution	150 – 300 microns [0.4 mm/0.016 in nozzle]

zortrax

Minimal Wall Thickness	450 microns [0.4 mm/0.016 in nozzle]
Platform Levelling	Automatic measurement of platform points' height; Manual measurement of platform points' height
Filaments	
Available Materials	Full offer is available at: https://zortrax.com/filaments
External Materials	Applicable
Support	Mechanically removed - printed with the same material as the model Water-soluble - printed with a different material than the model
Filament Container	Spool
Filament Diameter	1.75 mm [0.069 in]
Temperature	
Maximum Printing Temperature (Extruder)	310° C [590° F]
Maximum Platform Temperature	105° C [221° F]
Ambient Operation Temperature	20 - 30° C [68 - 86° F]
Storage Temperature	0 - 35° C [32 - 95° F]
Electrical	
AC Input	110 V ~ 5.9 A 50/60 Hz 240 V ~ 2.5 A 50/60 Hz
Maximum Power Consumption	400 W

zortrax

Software	
Software Bundle	Z-SUITE
Supported Input File Types	.stl, .obj, .dxf, .3mf
Supported Operating Systems	Mac OS up to Mojave version / Windows 7 and newer versions
Additional information	
Each delivered printer may have worked up to 90 hours during the quality control test prints	

Recycling

Disposal of paper and plastic packaging

To protect the environment, the Manufacturer recommends placing used paper and plastic packaging in specially designated containers, according to your local recycling guidelines.

Waste electrical and electronic equipment



This symbol indicates that it is electrical and electronic equipment which must not be disposed of with household waste. Substances contained in the equipment may be harmful to natural environment. Waste electrical and electronic equipment cannot be disposed of in landfills and must be recycled.

For information on where to dispose of waste equipment, contact the reseller, the Manufacturer, or the importer of the device. Disposing of waste electrical and electronic equipment along with other waste is prohibited by the Directive 2012/19/UE.

Certification



The Manufacturer ensures that the equipment complies with all relevant standards. In case of questions and problems, contact the Manufacturer through the support form: <http://support.zortrax.com/support-form/>.

zortrax

office: office@zortrax.com

technical support: support@zortrax.com

more information: zortrax.com

update: 14.10.2020

©2020 Zortrax S.A. All rights reserved.