

Creator Pro 2

Advanced | Reliable | Easy-to-use
Independent Dual Extruder System

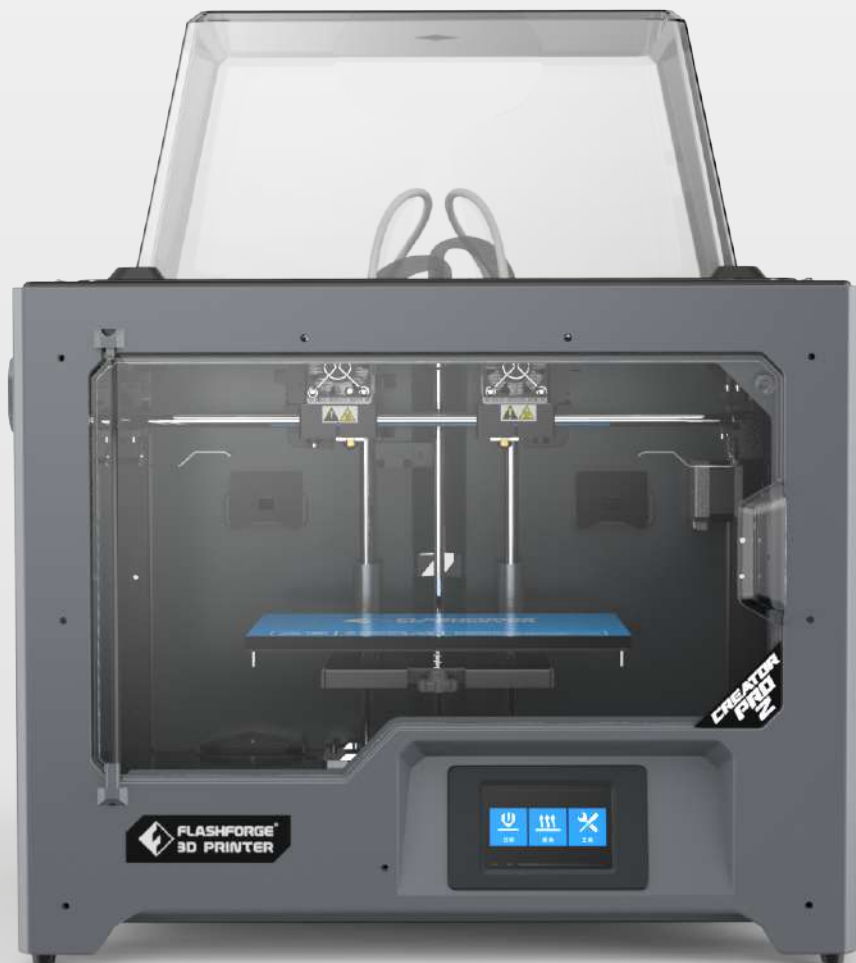

Creator Pro2 is the upgrade of the classical Creator Pro, with independent dual extruder system, productivity efficiency is faster and avoid to mixture of two filament in one object.

With touchscreen interface, the operation is simplified and easily. The classical closed machine structure ensures the printed results, especial for ABS printing.



Touchscreen interface
Closed printed chamber



Metal framework
Stable working performance



Support multiple materials
PLA, Pearl PLA, PVA, ABS, ABS Pro, HIPS



Independent dual extruder system
Support mirror printing mode, duplicate printing mode and soluble printing mode.



Build volume
200*148*150mm

Anti-scrape Design

Avoid scrap in the process of printing to get better printed results.

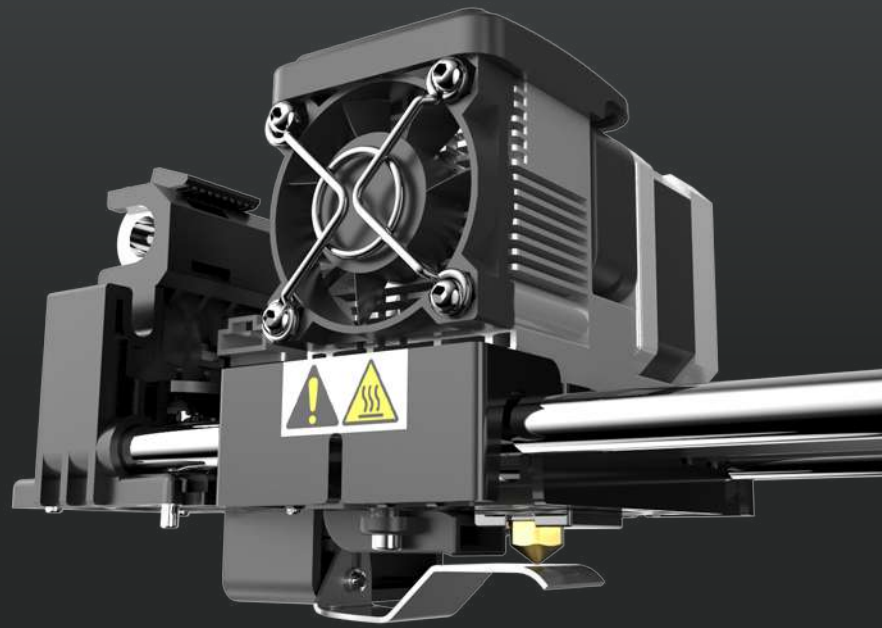

Nozzle Calibration



X-axis calibration



Y-axis calibration

Mirror Mode

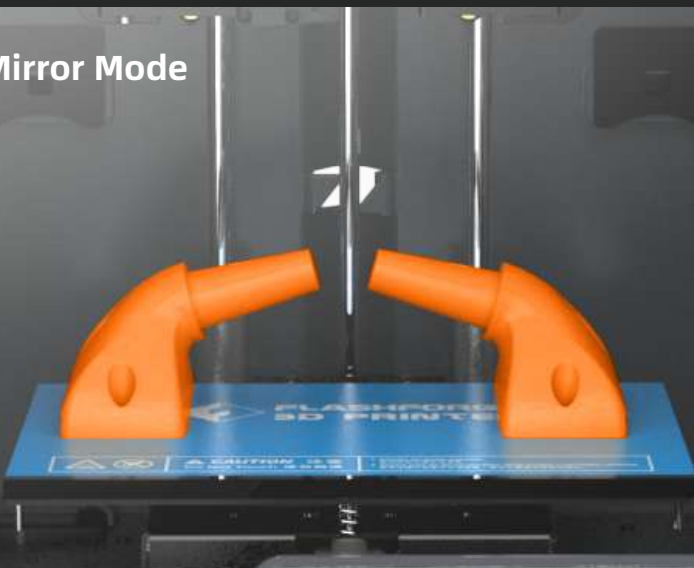

Duplicate Mode



Brand-new Upgraded Print Platform

Brand-new Upgraded Components
(Magnetic Plate + Flexible Steel Plate)

5000 times Bending Tests

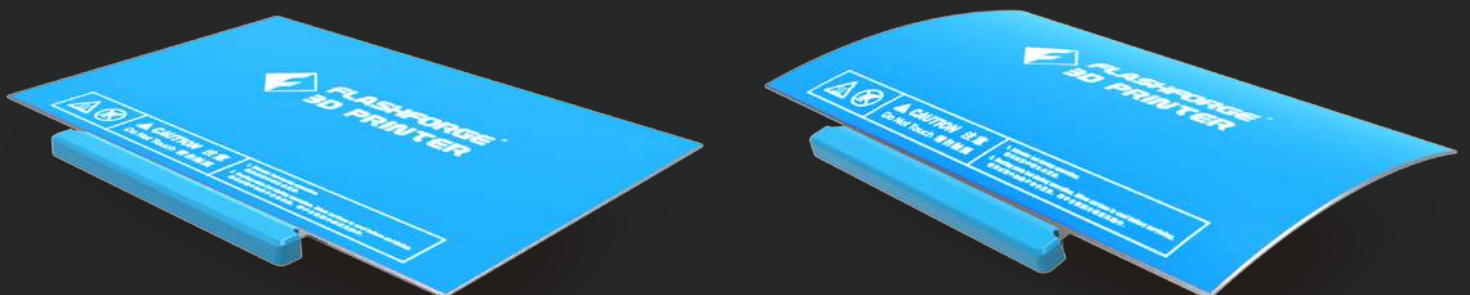
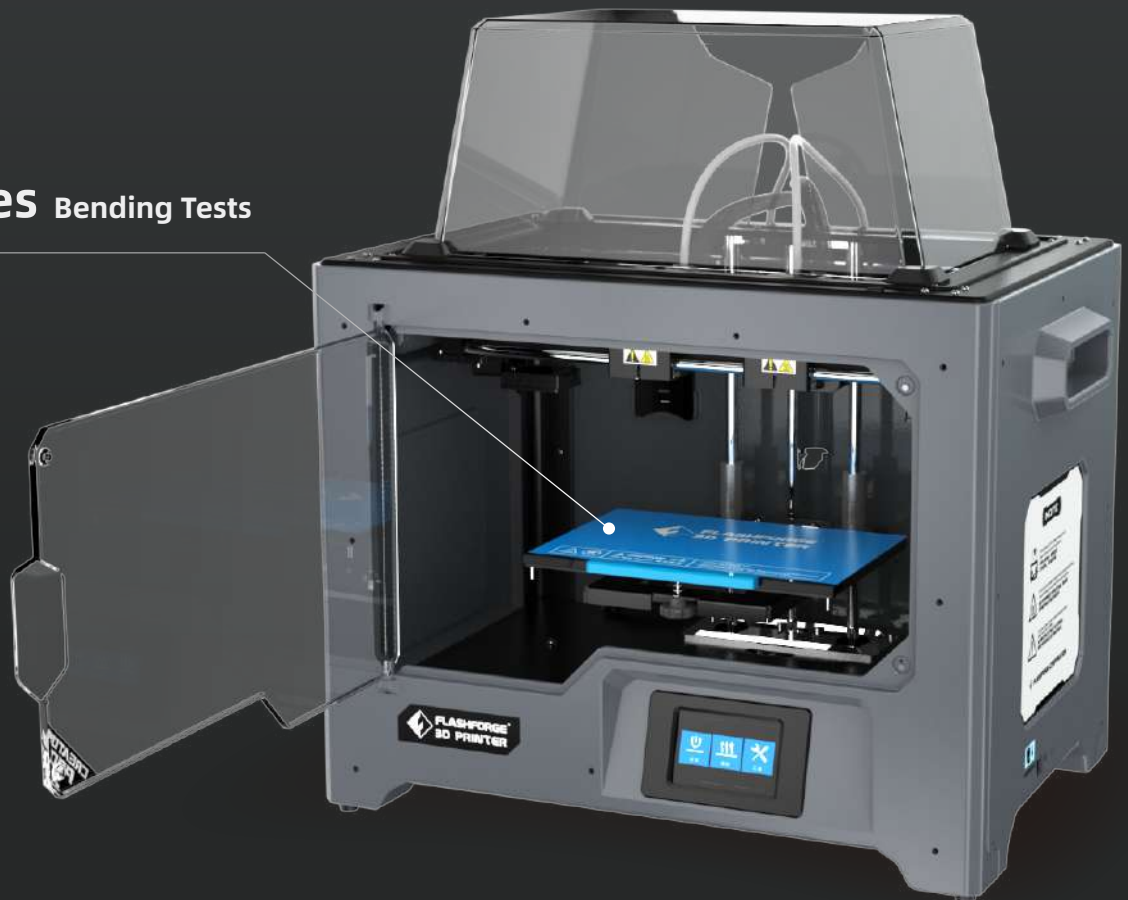

The flexible platform is adopted for more convenient remove of 3D models.
(The flexible platform assy is an optional part, not included in the parts list along with the printer)

Creator Pro 2 Printed Models

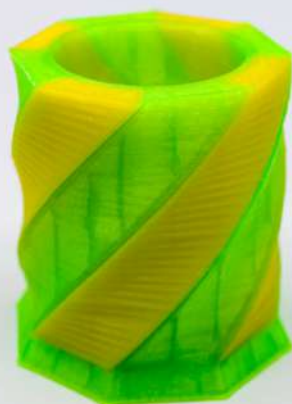



Open the front door and remove the top cover to let the air flow in, which is better for PLA printing.



Close the front door and the top cover to build a closed chamber, which is better for ABS printing.

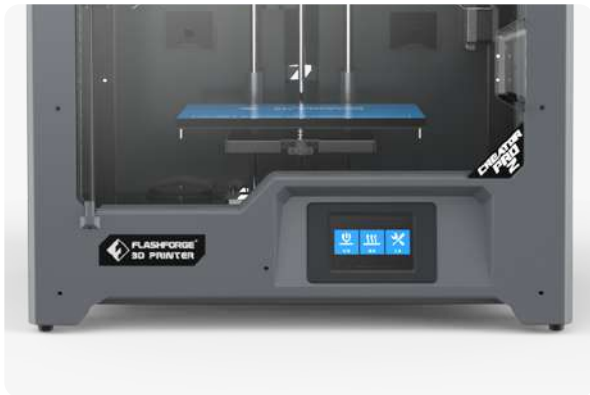

Touchscreen operation



SD card printing



Handle is designed for easy handling



Support two spool filaments in the back

PARAMETERS

PRINT

Extruder number:	2
Extruder diameter:	0.4mm
Highest set temperature of extruder:	240°C
Build Volume:	200*148*150mm
	Mirror mode: 80*148*150mm; Duplicate mode: 95*148*150mm
Print Speed:	10-100mm/s
Highest set temperature of platform:	120°C
Support Filament:	PLA, Pearl PLA, PVA, ABS, ABS Pro, HIPS

DEVICE

Printer Volume:	526*360*403 (550) mm
Screen:	Touch Screen
Net Weight:	15kg
Gross Weight:	21kg
Power:	100-240 VAC,47-63Hz
Internal Storage:	320w
Spool:	External

COMMUNICATION

Data transmission:	USB cable, SD card
Software:	FlashPrint
Output:	GX/G files
Input:	3MF/STL/OBJ/FPP/BMP/PNG/JPG/JPEG files